

Accessories: Mounting unit BES 08.0-KB-3

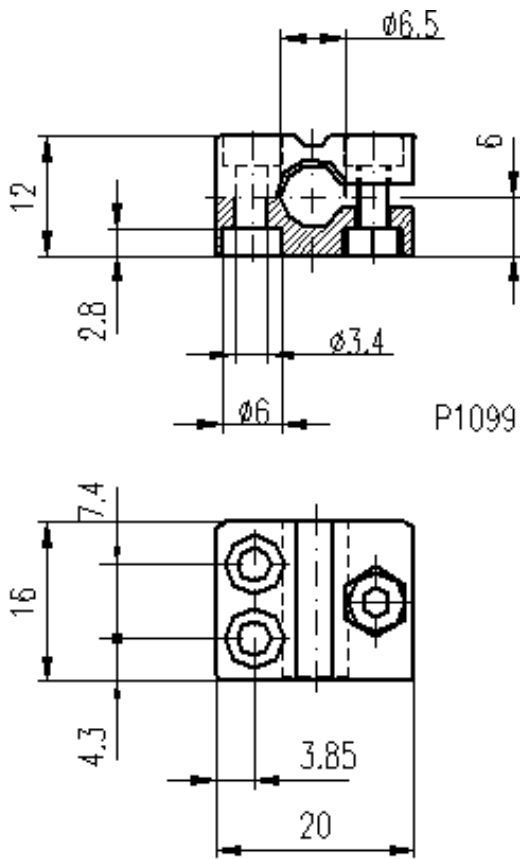

Common Data

Version
Usable with

Clamp
clamp without positive stop for
sensors D=8mm

Mechanical Data

Measurements WxHxD or Dia x D
Material
Mounting

20x16x12
PA6
with 2 screws M3

Datasheet number::

Definitions see general catalog.
If not otherwise noted, ratings according to
IEC 60947-5-2 (DIN EN60947-5-2)

Balluff GmbH
Schurwaldstrasse 9
73765 Neuhausen a.d.F.
Phone (07158) 173-0 Fax (07158) 5010

Datenblatt by CD-ROM - 04/2007

BALLUFF
sensors worldwide